

Uniden®

Voyager
Owner's Manual

OWNER'S MANUAL

Contents

Contents	1
Controls and Indications	2
LCD Display	3
Warning!	4
Lithium Ion Battery Pack Warning	4
Introduction	5
Features	5
Technical Support and Service	5
Included in your Package	6
Getting Started	7
Mounting the Drop-in Charger	7
Attaching the Antenna	7
Attaching the Battery Pack	8
Attaching the Beltclip	8
Charging the Battery Pack	9
SPKR/MIC Jack Cap	9
Connecting the SPKR/MIC	9
Operation	10
Turning On the Unit and Setting Squelch	10
Selecting a Channel	11
One-touch Channel 16/9	12
Triple Watch	12
Programming a Channel into Memory	13
Deleting a Channel from Memory	13
Scanning	13
Transmitting	14
Lighted Keys and Display	15
Battery Indicator	15
Key Lock	15
Tone Enable/Disable	16
Back Light Function Enable/Disable	16
Troubleshooting	17
Specifications	18
International Marine VHF Channel Chart	19
Warranty	22

Controls and Indicators

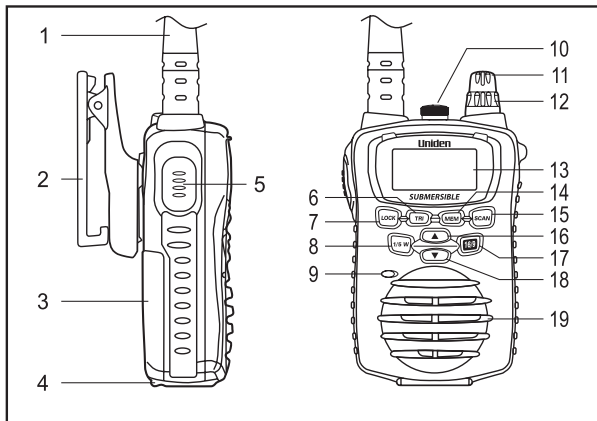

1. Antenna
2. Belt Clip
3. Battery
4. Battery Release Clip
5. PTT (Push to Talk) Key
6. Triple Watch Button (**TRI**)
7. Lock Button (**LOCK**)
8. TX Power / (**1/5W**)
9. Microphone
10. Speaker MIC Jack / Cap
11. Volume / Power Knob
12. Squelch Knob
13. LCD Display
14. Memory Button (**MEM**)
15. Scan Button (**SCAN**)
16. Channel Up Button ▲
17. 16/9 Button (**16/9**)
18. Channel Down Button ▼
19. Speaker

Controls and Indicators

LCD Display

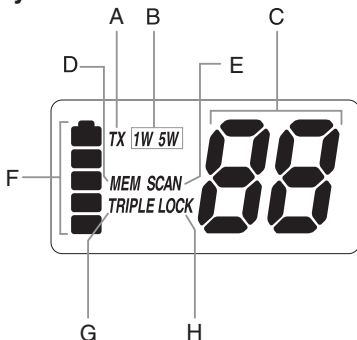

- A This indicator will appear only when the PTT switch is pressed and the radio is sending a transmission (**TX**).
- B This indicator indicate whether the transmitting power is **1W** or **5W**.
- C Channel Number Display.
- D This indicator will be displayed if the displayed channel is a memory (**MEM**) channel for scanning.
- E This Indicator will be displayed while in **SCAN** mode.
- F Battery Indicator - When battery is fully charged the display would look as the sample display. Battery levels are six levels of 0 to 5, which consist of five indicators.
- G This indicator will be displayed when **TRIPLE WATCH** is on.
- H This indicator will appear only when key **LOCK** function is on.

Warning!

- The VOYAGER is waterproof only when both the antenna, speaker mic cap and the battery are properly attached.
- Do not operate the transmitter of any radio equipment unless all the Radio Frequency (RF) connectors are secure and any open connectors are properly terminated.
- Do not operate the transmitter of any radio equipment near electrical blasting caps or in an explosive atmosphere.
- Do not let children operate any transmitter-equipped radio equipment without proper supervision.
- Have your radio equipment serviced by a qualified technician.



Lithium Ion Battery Pack Warning

- This equipment contains a Lithium Ion Battery Pack.
- Avoid exposing the Lithium Ion battery, attached or unattached to the radio, in direct sunshine, heated cars, or in areas with temperatures below -20°C (-4°F) or above $+60^{\circ}\text{C}$ ($+140^{\circ}\text{F}$). Exposing the chemicals contained within the battery pack to temperatures above $+60^{\circ}\text{C}$ ($+140^{\circ}\text{F}$) may cause the battery to rupture, fail or reduce performance.
- In case of exposure to cell contents, wash the affected area thoroughly, and seek medical attention.
- The Lithium Ion Battery Pack contained in this equipment may explode if disposed of in a fire.
- Do not short-circuit the Battery Pack.
- Do not charge the Lithium Ion Battery Pack used in this equipment in any charger other than the one designed to charge this Battery Pack. Using another charger may damage the Battery Pack or cause the Battery Pack to explode.
- Lithium Ion batteries must be disposed of properly.

Introduction

The VOYAGER is a waterproof, portable two-way VHF transceiver. It is compact, lightweight, rugged and fits easily in your hand. This handheld VHF marine radio will give you consistent, outstanding performance in virtually all conditions and situations.

To ensure that you get the most from the Voyager features, please read this operating guide carefully before using the unit.

Features

- Waterproof (meets JIS7 waterproof specifications: submersible at 1.0m depth for up to 30minutes)*
- Triple Watch Mode
- Priority Channel Startup (Channel 16)
- Programmable Memory
- One-Touch Channel 16/9
- Memory Scan
- International Channels
- Table-Top Drop-In Charger (can also be wall-mounted)
- Rechargeable Lithium Ion Battery Pack
- Battery Save Operation
- Key Lock
- Back-Lit Keys and Display
- Belt Clip
- Wrist Strap
- TX Power 1W/5W

* The VOYAGER radio meets waterproof (JIS7) specifications only when the battery, the antenna and speaker MIC jack cap are correctly installed. The VOYAGER will retain its JIS7 rating when the accessory Speaker MIC is connected correctly but the Speaker MIC itself is not splash or waterproof.

Technical Support and Service

If your marine radio does not perform properly, follow the troubleshooting tips in the back of this operating guide. Unauthorized adjustment will void the warranty.

Included in your Package



VOYAGER



AC Adapter



Antenna



DC Adapter

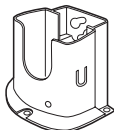

Drop-in Charger



Lithium Battery



Beltclip



Wrist Strap



Mounting Screws



Reference Guide/
Printed Material



Speaker Microphone
SM078

Getting Started

Mounting the Drop-in Charger

- 1** Mount the drop-in charger to either a counter or wall.

To counter:

Attach the drop-in charger using the mounting screws and washers as follows.

To wall:

Insert the two mounting screws into the wall keeping the same space as the holes on the charger.

- 2** Place the charger with the screws through the larger holes then turn the charger.

- 3** Plug one end of the AC adapter into the wall outlet and the other end into the drop-in charger.

- 4** When you mount the drop-in charger on your boat, use the DC adapter instead.

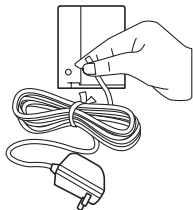
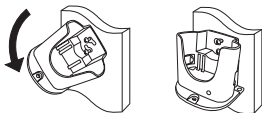
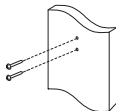
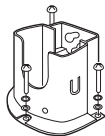

Attaching the Antenna

Attach the antenna to the **VOYAGER**. Be sure the antenna is firmly seated.

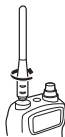

Getting Started

Attaching the Battery Pack

- 1 Place the battery pack onto the back of the radio. It will only fit in one way.
- 2 Snap the battery release clip until it clicks. Be sure the battery pack fits tightly against the **VOYAGER's** body.

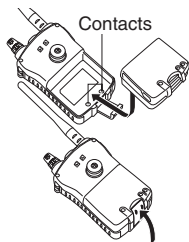

Attaching the Beltclip

- 1 Hold the beltclip in the direction as follows.
- 2 Apply it to the hanger piece on the back of the radio. Then slide it up.
- 3 You will hear a click. The beltclip is firmly attached.
- 4 To take the beltclip off the radio, turn it and slide it up.

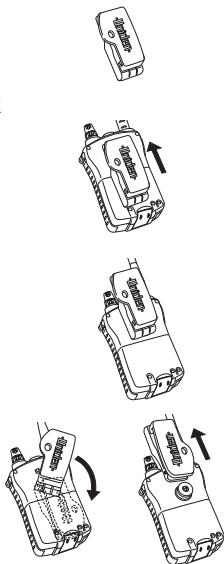

Getting Started

Charging the Battery Pack

Your marine radio is powered by a specially designed Lithium Ion battery pack.

- Before operating the **VOYAGER**, charge the Lithium Ion battery pack for 6 hours ***without interruption*** in the drop-in charger.

1 Place the **VOYAGER** in the drop-in charger.

2 The red LED illuminates and stays on.

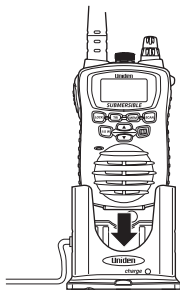

- The charger won't overcharge the battery pack. When charging is completed, the charge LED is no longer illuminated.
- **Do not transmit when the VOYAGER is in the drop-in charger!**
- You can monitor incoming calls while the **VOYAGER** is in the drop-in charger.

SPKR/MIC Jack Cap

Make sure the SPKR/MIC jack cap is screwed tight to maintain submersible rating. Tighten the screw cap clockwise with the use of a coin.

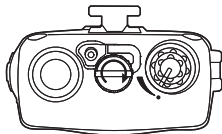

Connecting the SPKR/MIC

Unscrew the SPKR/MIC jack cap to plug in the SPKR/MIC. Secure the SPKR/MIC plug by tightening the plug screw clockwise.

Operation

- See “Controls and Indicators” (page. 2) for button, knob, and key positions.
- When you turn on your **VOYAGER**, it is automatically tuned to channel 16, frequency for distress, safety, and calling.
- When you press any key (except **PTT**), a short tone sounds.

Turning On the Unit and Setting Squelch

- 1** Before you turn on the unit, turn the **Squelch** knob fully counterclockwise.
- 2** Then, turn on the unit by turning the **Volume/Power** knob clockwise until you hear a hissing sound.
- 3** Turn the Squelch knob clockwise, just until the hissing sound stops. Use the knob to adjust to the desired squelch level. Think of the squelch control as a frequency gate which controls access to weak or strong signals depending on its setting.

- To listen to a weak or distant station, turn the knob counterclockwise. If reception is poor, turn it clockwise to cut out weak transmissions.
 - If the squelch control is adjusted so you continually hear a hissing sound, the unit will not scan properly.
- 4** To turn off the unit, turn the **Volume/Power** knob counterclockwise until it clicks.

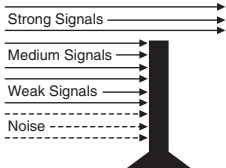
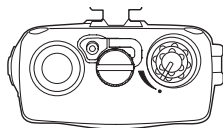

Operation

Selecting a Channel

- 1 Turn on your **VOYAGER**.
 - 2 To select a higher channel, press the ▲ button.
 - 3 To select a lower channel, press the ▼ button.
- To change the channel continuously, press and hold the ▲ or ▼ button for more than 1 second.



↓ [UP]

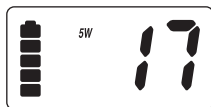

↓ [DOWN]

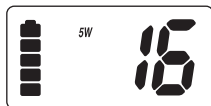

Operation

One-touch Channel 16/9

Example: While you are monitoring channel 20, you want to check channel 16 or channel 9.

1

You are now on channel 20.

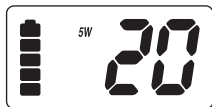

2

To monitor channel 16, press the **16/9** button.

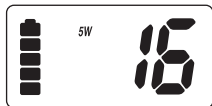

3

To monitor channel 9, press the **16/9** button again.

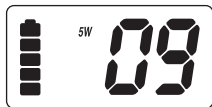

4

To return to channel 20, press the **16/9** button again.

Triple Watch

Triple Watch mode monitors channels 16 and 9 for a signal while you listen to the currently selected channel. The marine radio checks channel 16 and 9 for activity every 2 seconds.

1

To select Triple Watch mode, press the **TRI** button.
"TRIPLE" appears on the display.

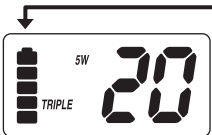

2

To exit from Triple Watch, press the **TRI** button again.

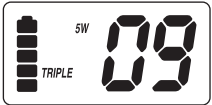

"TRIPLE" disappears on the display.

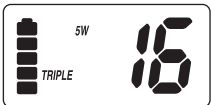

Operation

- While in Triple Watch mode, you can change the currently selected channel using the ▲ or ▼ button.
- A momentary press of the **16/9** button interrupts Triple Watch mode and remains on 16, or on channel 9 if you press once more. To return to the previous mode, simply press the button again.
- It becomes Dual Watch when Triple Watch function is turned on while CH9 or CH16 is displayed.

Programming a Channel into Memory

Before using the scanning feature, you have to program channels into memory.

- 1 Select the channel to enter into memory by pressing the ▲ or ▼ button.

- 2 Press the **MEM** button to store the channel.
MEM appears on the display.

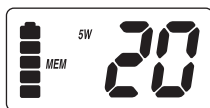

Deleting a Channel from Memory

- 1 Select the channel to delete from memory by pressing the ▲ or ▼ button.

- 2 Press the **MEM** button.
MEM disappears from the display.

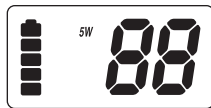

Scanning

- 1 To begin scanning the programmed channels, press the **SCAN** button.
SCAN and **TRIPLE** appear on the display.

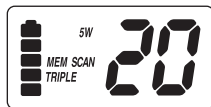

Operation

2 To stop scanning, press the **SCAN** button once more. **SCAN** and **TRIPLE** disappear from the display.

- Scanning starts from the lowest to highest channel and stops when it finds an active channel. It remains on that channel until the transmission ends, then resumes scanning after a 3 second delay period.
- When in the scan mode, the unit automatically activates the Triple Watch feature. To deactivate Triple Watch from the scanning mode, press the **TRI** button. **TRIPLE** disappears from the display.

Transmitting

1 Transmission power can be set to either 5W or 1W.

Press the **1/5W** button to make the change, then the **5W** or the **1W** indicator on the display changes accordingly.



TX Power will be set to 5W when is changed to 16CH. The TX Power is able to change to 1 W at 16CH by pressing **1/5W**.

2 To transmit, press and hold the **PTT** key. **TX** appears on the display.

3 To return to receive, release the **PTT** key. **TX** disappears from the display.

- If the **PTT** key is pressed for more than 5 minutes, **TX** starts blinking and the transmission ends. The TX time out tone will sound until the **PTT** key is released.
- If the battery indicator drops to the 1-mark level on the display, when the **PTT** key is pressed, the radio will not transmit and the **TX** icon starts blinking. (Refer to the description of the Battery Indicator on the next page.)

Operation

Lighted Keys and Display

To light the display, press any key excluding the **PTT** key.

- If you press any button other than the **PTT** key while the display and keypad are illuminated, it remains illuminated for another 5 seconds.

Battery Indicator

When the unit is on, battery power is always indicated on the display.

When the battery is fully charged, the battery indicator appears as follows:

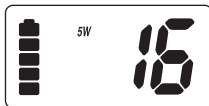

When the battery is nearly discharged, the battery indicator appears as follows:

- When the battery indicator drops to the 1-mark level on the display, the radio will receive but will not transmit.



Key Lock

To prevent accidental entries, you can lock the keypad.

1 Press and hold the **LOCK** key for 1.5 seconds. The unit will beep two times to confirm that the keypad is locked with **LOCK** indication on the display.

2 To unlock the keypad, press and hold the **LOCK** key again for 1.5 seconds. The unit will beep twice to confirm that the keypad is unlocked, and **LOCK** will disappear.

- You can also unlock the keypad by turning the radio off and then on again.

Tone Enable/Disable

The Tone sounds can be enabled/disabled as follows;

- 1 Turn on the radio while pushing and holding [▼] sw.

The Tone enable/disable will be switched.

- * When Tone enable is selected, all the tone sounds.
- * When Tone disable is selected, all the tone does not sound.

When power switch is turned on without pressing [▼] sw, the previous setting of Tone enable/disable is kept.

Back Light Function Enable/Disable

This Back Light Function can be enabled/disabled as follows;

- 1 Turn on the radio while pushing and holding [▲] sw.

The Back Light function enable/disable will be switched.

- * When Back Light enable is selected, Back Light function activates.
- * When Back Light disable is selected, Back Light function does not activate.

When power switch is turned on without pressing [▲] sw, the previous setting of Back Light enable/disable is kept.

Troubleshooting

- **Will not transmit on 5 watt range but will transmit on the 1 watt range**
Cause: Low voltage
⇒ Recharge or replace the batteries
- **Will not transmit while on the charger**
Cause: Low voltage
⇒ The unit is not designed to transmit while on the charger. The charger does not supply enough power for transmitting.
- **Battery will not charge**
Cause: Charger inoperative
⇒ Replace charger. Damage to the charger can be a result of keying up the radio while on the charger.

Specifications

General

Channels	Transmit	56 International
	Receive	57 International
Frequency Control		PLL
Frequency Tol.	Transmit	± 1 PPM (at 25 ° C)
	Receive	± 1 PPM (at 25 ° C)
Oper. Temp.		-20°C to + 55°C
Antenna		Flexible Whip
Microphone		Built-in Electret type
Display		Liquid Crystal Display
Speaker		8 ohms, 1 Watt
Power Source		Rechargeable Lithium Ion Battery Pack 7.4V 850 mAh
Size (without antenna)		97 (H) x 62 (W) x 33 (D) mm
Weight (w/battery & antenna)		8.8 oz (250g)

Transmitter

Frequency Range	156.025 MHz to 157.425 MHz
Power Output	1.0 W & 5 W
Spurious Emissions	-38 dBm (5W)
Current Drain	500mA (1W), 1400mA (5W)

Receiver

Receiver Type	Double Conversion Super Heterodyne Phase
Frequency Range	156.300 MHz to 162.000 MHz
Sensitivity	0.45uV for 20dB SINAD
Squelch Sensitivity	Threshold 0.25uV
Audio	± 6 dB 500 to 2010 Hz
Frequency Response	
Adjacent Channel	70 dB @ ± 25 kHz
Audio Output Power	0.6 W @ 10 % THD
Current Drain	Squelched 40 mA
	Max. audio 250 mA

Marine Channels - International

Channel Desig	Frequency (MHz)		Traffic Type	Ship to Ship	Ship to Shore	Permanent Scan List
	Transmit	Receive				
01	156.050	160.650	Duplex	Yes	Yes	
02	156.100	160.700	Duplex	Yes	Yes	
03	156.150	160.750	Duplex	Yes	Yes	
04	156.200	160.800	Duplex	Yes	Yes	
05	156.250	160.850	Duplex	Yes	Yes	
06	156.300	156.300		Yes	No	
07	156.350	160.950	Duplex	Yes	Yes	
08	156.400	156.400		Yes	No	
09	156.450	156.450		Yes	Yes	
10	156.500	156.500		Yes	Yes	
11	156.550	156.550		Yes	Yes	
12	156.600	156.600		No	Yes	
13	156.650	156.650		Yes	Yes	
14	156.700	156.700		Yes	Yes	
15	156.750	156.750		Yes	Yes	
16	156.800	156.800		Yes	Yes	
17	156.850	156.850		Yes	Yes	
18	156.900	161.500	Duplex	Yes	Yes	
19	156.950	161.550	Duplex	No	Yes	
20	157.000	161.600	Duplex	No	Yes	
21	157.050	161.650	Duplex	No	Yes	
22	157.100	161.700	Duplex	No	Yes	
23	157.150	161.750	Duplex	No	Yes	
24	157.200	161.800	Duplex	No	Yes	
25	157.250	161.850	Duplex	No	Yes	
26	157.300	161.900	Duplex	No	Yes	
27	157.350	161.950	Duplex	No	Yes	
28	157.400	162.000	Duplex	No	Yes	
60	156.025	160.625	Duplex			
61	156.075	160.675	Duplex			
62	156.125	160.725	Duplex			
63	156.175	160.775	Duplex			
64	156.225	160.825	Duplex			

Marine Channels - International

Channel Desig	Frequency (MHz) Transmit Receive	Traffic Type	Ship to Ship	Ship to Shore	Permanent Scan List
65	156.275 160.875	Duplex	Yes	Yes	
66	156.325 160.925	Duplex	Yes	Yes	
67	156.375 156.375		Yes	No	
68	156.425 156.425		Yes	Yes	
69	156.475 156.475		Yes	Yes	
70	RX Only 156.525				
71	156.575 156.575		Yes	Yes	
72	156.625 156.625		Yes	No	
73	156.675 156.675		Yes	Yes	
74	156.725 156.725		Yes	Yes	
75	156.775 156.775	1W	Yes	No	
76	156.825 156.825	1W	Yes	No	
77	156.875 156.875		Yes	No	
78	156.925 161.525	Duplex	Yes	Yes	
79	156.975 161.575	Duplex	Yes	Yes	
80	157.025 161.625	Duplex	Yes	Yes	
81	157.075 161.675	Duplex	Yes	Yes	
82	157.125 161.725	Duplex	Yes	Yes	
83	157.175 161.775	Duplex	Yes	Yes	
84	157.225 161.825	Duplex	Yes	Yes	
85	157.275 161.875	Duplex	No	Yes	
86	157.325 161.925	Duplex	No	Yes	
87	157.375 157.375		No	Yes	
88	157.425 157.425		Yes	No	

Memo

Warranty

UNIDEN Voyager Two Year Limited Warranty

IMPORTANT Evidence of the original purchase is required for warranty service.

Warrantor: Uniden Australia Pty Limited A.B.N. 58 001 865 498
Uniden New Zealand Limited

Elements of Warranty: Uniden warrants to the original retail owner for the duration of this warranty its Voyager (hereinafter referred to as the Product), to be free from defects in materials and craftsmanship with only the limitations or exclusions set out below.

Warranty Duration: This warranty to the original retail owner only is only valid in the original country of purchase and shall be of no further effect 2 years after the date of original retail sale. This warranty will be deemed invalid if the Product is: (A) Damaged or not maintained as reasonable and necessary, (B) Modified, altered or used as part of any conversion kits, subassemblies, or any configurations not sold by Uniden, (C) Improperly installed, (D) Repaired by someone other than an authorized Uniden Repair Agent for a defect or malfunction covered by this warranty, (E) Used in conjunction with any equipment or parts or as a part of a system not manufactured by Uniden. (F) Only available in the original country of sale.

Parts Covered: This warranty covers for two (2) years, the Product and included accessories.

Statement of Remedy: In the event that the Product does not conform to this warranty at any time while this warranty is in effect, the warrantor, at its discretion, will repair the defect or replace the Product and return it to you without charge for parts and service. This warranty does not provide for reimbursement or payment of incidental or consequential damages. This EXPRESS WARRANTY is in addition to and does not in any way affect your rights under the TRADE PRACTICES ACT 1974 (Cth) (Australia) or the CONSUMER GUARANTEES ACT (New Zealand).

Procedure for obtaining performance or warranty: in the event that the Product does not conform to this warranty, the Product should be shipped or delivered, freight prepaid, with evidence of original purchase (e.g. a copy of the sales docket) to the warrantor at:

UNIDEN AUSTRALIA PTY LTD
Service Division
345 Princes Highway,
Rockdale, NSW 2216
Fax (02) 9599 3278
www.uniden.com.au

UNIDEN NEW ZEALAND LTD
Service Division
150 Harris Road, East Tamaki,
Auckland
Fax (09) 274 4253
www.uniden.co.nz

Uniden®

© 2008 Uniden Australia Pty Limited/Uniden New Zealand Limited
Printed in China UTZZ01626ZZ(0)