

Uniden®
OWNER'S MANUAL



**UNIDEN Model uh012sx UHF
CB Radio**

Contents

Introduction	2
Features	2
Preventative Maintenance	2
Troubleshooting	2
Controls/Connectors	3
Indicators	4
Included with your uh012sx	5
Operation	6
Setting the FM Squelch	6
Selecting a Channel	7
Transmitting	7
Using Repeater Channels	7
Operating the uh012sx in Duplex Mode	8
Scanning (Open Scan)	8
Open Scan (OS) Mode	8
Programming the Instant Priority Channel	9
Recalling the Instant Channel	9
Continuous Tone Coded Squelch System (CTCSS)	9
UHF CB Channels & Frequencies	10
Warranty	11

UNIDEN Model uh012sx UHF CB Radio

Introduction

The Uniden uh012sx is designed to provide you with years of trouble free service. Its rugged components and materials are capable of withstanding harsh environments. Please read this Operating Manual carefully to ensure you gain the optimum performance of the unit.



The citizen band radio service is licenced in Australia by ACMA Radio-communications (Citizen Band Radio Stations) Class Licence and in New Zealand by MED General User Licence for Citizen Band Radio and operation is subject to conditions contained in those licenses.

Features

- Transmit and Receive FM 40CH (UHF-CB, TX Power 5w)
- 7 Segments LED
- Instant Channel (programmable)
- One touch Instant Channel recalling
- Duplex Capability (from CH01 - CH08 per channel)
- Open Scan
- 38 Built-in CTCSS codes
- Rotary Channel Select
- Variable Squelch Level Adjust
- Volume Control with Power On/Off Switch.
- Compact Dimensions: 127mm(w) x 36mm(h) x 148mm(l)

Preventative Maintenance:

The following system checks should be made every six to twelve months:

- Check the Standing Wave Ratio (SWR).
- Inspect the tightness of all electrical connections.
- Inspect the antenna coaxial cable for wear or breaks on the shielding.
- Inspect the tightness of all screws and other mounting hardware.

Troubleshooting:

Should the unit malfunction or perform poorly, follow these procedures.

If the transceiver is completely inoperative...

- Check the power cord and fuse.

If there is trouble with receiving...

- Check the VOLUME control setting. Be sure the SQUELCH is adjusted properly. Possibly the radio is over-squelched.
- Check the CTCSS code.

If there is trouble with transmitting...

- Check that the transmission line (coaxial cable) is securely connected to the ANTENNA connector.
- Check that the antenna is fully extended for proper operation.
- Check that all transmission line (coaxial cable) connections are secure and free of corrosion.

Memory Backup:

UNIDEN Model uh012sx UHF CB Radio

Controls/Connectors

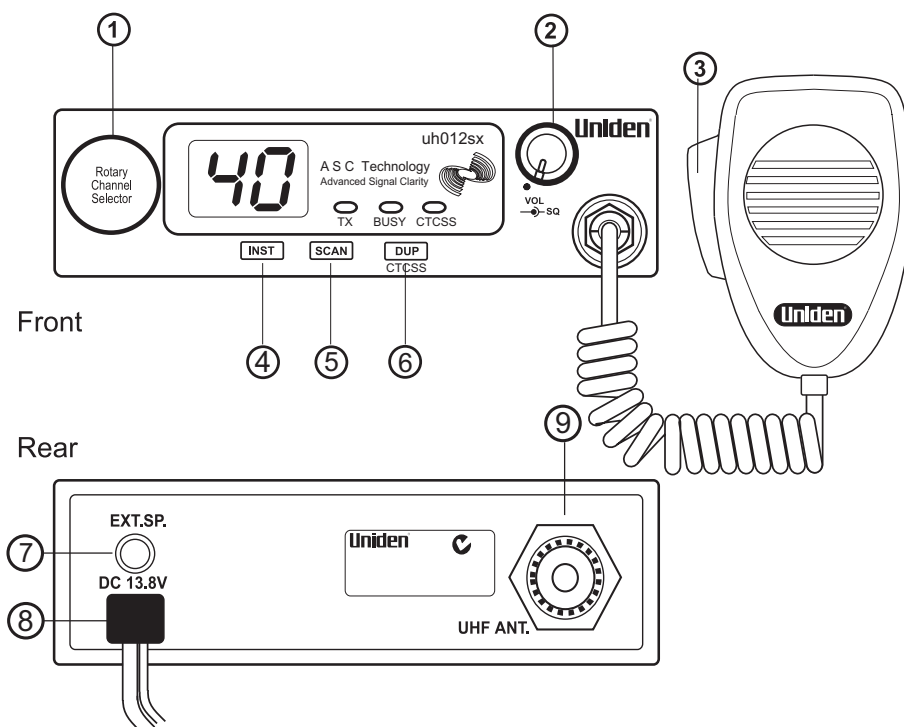

Controls and Connectors

Ref	Item	Page	Ref	Item	Page
①	Rotary Channel Selector	7	⑥	DUP - Duplex On/Off /CTCSS - Continuous Tone Coded Squelch System	8
②	On/Off Volume & Squelch	6	⑦	External Speaker Jack	-
③	Push to Talk (PTT) Switch	7	⑧	Power Input (13.8V DC)	2
④	INST - Instant Channel Recall & Instant Channel Programming	9	⑨	UHF Antenna Connection	2
⑤	SCAN - Scan On/Off	8			

UNIDEN Model uh012sx UHF CB Radio

Indicators

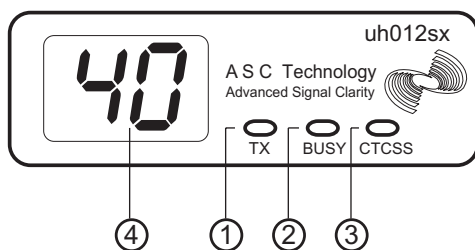

Indicators

- ① **TX LED** It is turned on when transmitting condition.
- ② **BUSY LED** It is turned on when receiving a signal or decoding a CTCSS code. It blinks while receiving a signal in scan mode.
- ③ **CTCSS LED** It is turned on when the current displayed channel has CTCSS set. It blinks when the CTCSS code is decoded OK.
- ④ **CH LED (40)** Indicates the Channel Number.

UNIDEN Model uh012sx UHF CB Radio

Included with your uh012sx

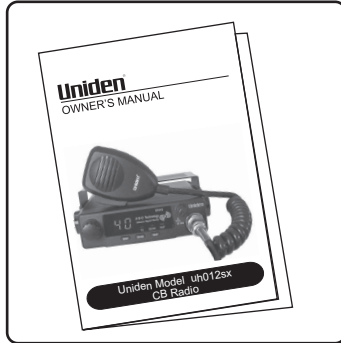

uh012sx Owners Manual

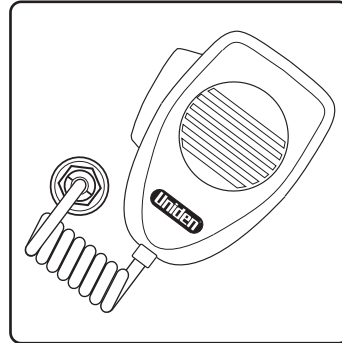

Microphone

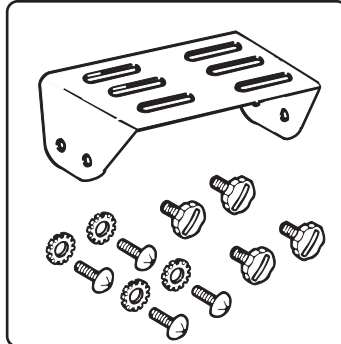

Mounting Bracket, Knobs
Rubber Washer, Washer Stars
And Screws

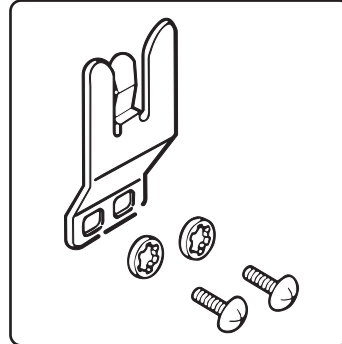

Microphone Hanger, Screws
and Washers

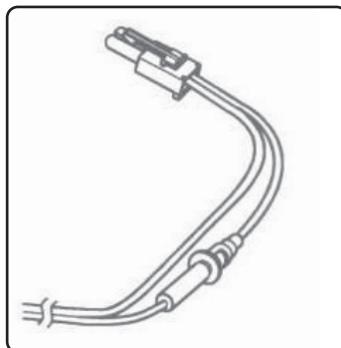

DC Power Cord with fuse

Optional Accessories

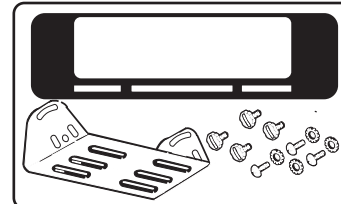

DIN Mounting Kit (DMK8990)



External Speaker (MS100)

UNIDEN Model uh012sx UHF CB Radio

Operation

Setting the FM Squelch

Turn the Unit ON by rotating the volume control clockwise. Turn the outer ring of the control to adjust the Squelch.

NOTE You must select a channel which is not in use before setting the SQUELCH control. (see p.7)

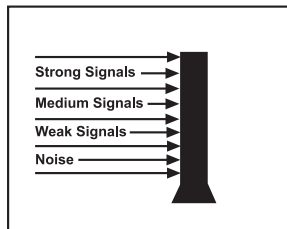
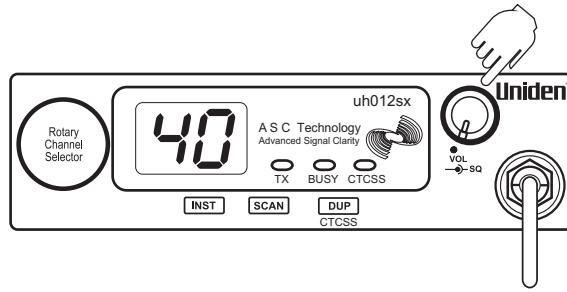

Think of the squelch control as a gate. If you turn Squelch fully clockwise it raises the 'Squelch gate' so high that no signals get through.

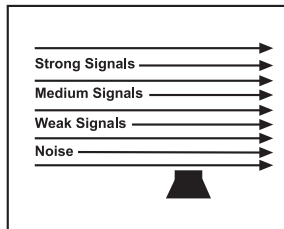

If you turn the Squelch fully counterclockwise it lowers the 'Squelch Gate' to the extent that all signals get through - weak, medium and strong signals and noise.

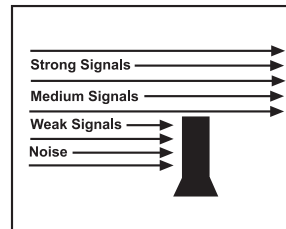

To set the 'Squelch Gate' to the desired level, turn the squelch knob counterclockwise until you hear noise. Then carefully turn the Squelch knob clockwise until the noise fades. Now only strong signals get through.

Operation

Selecting a Channel

Turn the Rotary Channel Selector to select the desired *channel*.



For your reference a list of the available channels, corresponding frequencies and guidelines for their use is printed on page 10. For Australia, Channels 05 and 35 are reserved for Emergency Calls.

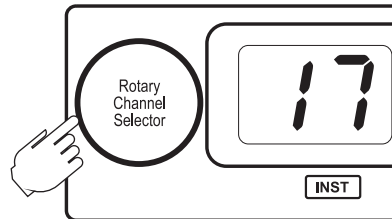

Transmitting

The uh012sx uses the 40 UHF-CB Channels (**Channels 22 and 23 are for telemetry and telecommand applications. Transmit is inhibited on these channels**).

Select the desired channel. Press the microphone's PTT button and speak normally into the microphone. Hold it approx. 7cm from your mouth. Release the PTT button to end the transmission and listen for a reply.

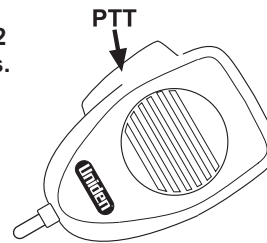

Using Repeater Channels

UHF CB repeaters are used to retransmit or relay your signal. Repeaters will extend the range of your radio and overcome the shielding effect caused by solid obstructions. In normal Simplex operation, your radio transmits on one particular frequency and receives on that same frequency. If there is a barrier that partially blocks your transmitted signal, the probability of another radio receiving the signal is very slim. Hills, tall buildings, metallic structures,...etc tend to act as a screen between radios.

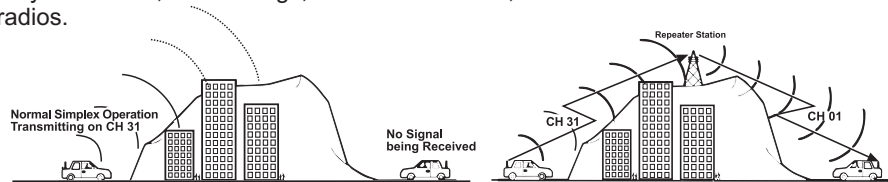

Standard Operation without the aid of a Repeater Station.

Operation with the aid of a Repeater Station (Duplex).

The signal coming from your radio is received by the Repeater Station and the re-transmitted at the same time on another channel. This operation is called "Duplexing".

For example,

CH01 on Duplex Mode will Receive on CH01 but Transmit on CH31

CH02 on Duplex Mode will Receive on CH02 but Transmit on CH32 etc...

If you transmit on CH01 Duplex mode, you are actually transmitting on CH31 the repeater station down-converts your signal and retransmits on CH01.

Operation

Operating the uh012sx in Duplex Mode

For this example we are adopting CH01 as the channel being used in your area for repeater use.

Press **[DUP]** to switch Duplex On.

"r" (for repeater) is displayed in place of the 1st digit of the channel number indicator. e.g. 01 : normal channel 1
r1 : duplex channel 1

If Duplex is not required - press **[DUP]** again to switch Duplex off.
Only channels 01 - 08 are available for Duplex.

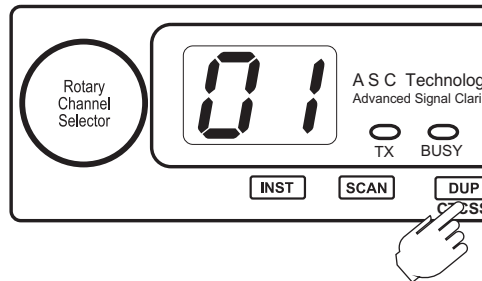

NOTE Check with your local Retailer for information on available repeaters.

Scanning (open scan)

The uh012sx has a scanning feature that allows you to search for active channels automatically.

Press **[SCAN]** and Scanning starts.

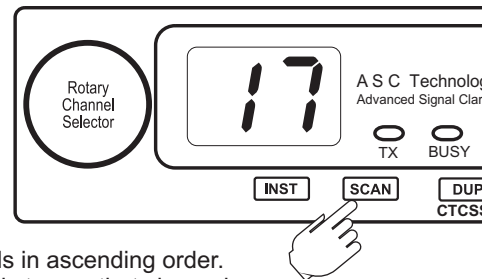

Open Scan (OS) Mode

Allows continuous scanning of all channels in ascending order.
If an active channel is found, scanning will stop on that channel.

If the received signal ceases, the unit will wait 3 seconds for the signal to return, otherwise scanning resumes.

To deactivate SCAN, press **[SCAN]** or the PTT button on the microphone.

NOTE If SCAN is deactivated while on an active channel, the uh012sx will stay on that channel. If no channels are active, the uh012sx will reinstate the starting channel.

Operation

Programming the Instant Priority Channel

Turn the Rotary Channel Selector to select the Priority Channel you prefer.

Press and hold **INST** for 1.5 seconds to store the new setting.

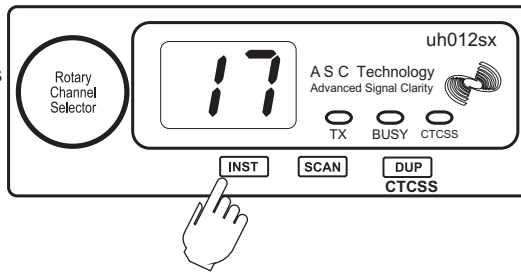

Recalling the Instant Channel

Momentarily press the **INST** key at any time to return to the Instant Channel (except during CTCSS CODE setting).

Continuous Tone Coded Squelch System (CTCSS)

This feature allows signals to be received only from callers who have selected the same CTCSS code.

Turn the Rotary Channel Selector to select the channel you want to set CTCSS code.

Press and hold **DUP/CTCSS**. The channel display will flash the CTCSS code.

Turn the Rotary Channel Selector to select a desired CTCSS code. If you select oF and press **DUP/CTCSS** then CTCSS will not set and CTCSS LED will be off.

If you select a code from 01 to 38 and press **DUP/CTCSS** then the selected code is set and CTCSS LED will be on.

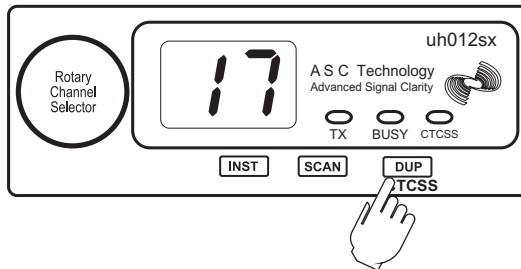

If there is no selection for 10 seconds the operation is timed out.

NOTE Channels 05 and 35 are Emergency Channels. CTCSS will not operate on these channels.

UNIDEN Model uh012sx UHF CB Radio

UHF CB CHANNELS & FREQUENCIES

NOTE

Please follow these guidelines for channel use in Australia:

- Channels 05 and 35 are Emergency Channels.
- Channel 11 is a Calling Channel.
- Channels 22 and 23 are for telemetry and telecommand applications and TX is inhibited on these channels.

General communication is accepted on all other channels with these guidelines:

- Channel 40 - road channel (Australia).
- Channels 01-08 (and 31-38) are repeater channels.

CH No.	Simplex Mode Transmit / Receive Frequency (MHz)	Duplex Mode Transmit Frequency (MHz)	CH No.	Simplex Mode Transmit/Receive Frequency (Mhz)
1	476.425	477.175 CH31	21	476.925
2	476.450	477.200 CH32	22	476.950 (RX only)
3	476.475	477.225 CH33	23	476.975 (RX only)
4	476.500	477.250 CH34	24	477.000
5	476.525	477.275 CH35	25	477.025
6	476.550	477.300 CH36	26	477.050
7	476.575	477.325 CH37	27	477.075
8	476.600	477.350 CH38	28	477.100
9	476.625		29	477.125
10	476.650		30	477.150
11	476.675		31	477.175
12	476.700		32	477.200
13	476.725		33	477.225
14	476.750		34	477.250
15	476.775		35	477.275
16	476.800		36	477.300
17	476.825		37	477.325
18	476.850		38	477.350
19	476.875		39	477.375
20	476.900		40	477.400

CTCSS Code LIST

Code No.	Frequency (Hz)	Code No.	Frequency (Hz)	Code No.	Frequency (Hz)
"oF"	OFF	13	103.5	26	162.2
1	67.0	14	107.2	27	167.9
2	71.9	15	110.9	28	173.8
3	74.4	16	114.8	29	179.9
4	77.0	17	118.8	30	186.2
5	79.7	18	123.0	31	192.8
6	82.5	19	127.3	32	203.5
7	85.4	20	131.8	33	210.7
8	88.5	21	136.5	34	218.1
9	91.5	22	141.3	35	225.7
10	94.8	23	146.2	36	233.6
11	97.4	24	151.4	37	241.8
12	100.0	25	156.7	38	250.3

UNIDEN Model uh012sx UHF CB Radio

WARRANTY

UNIDEN uh012sx UHF CB Radio

Two Year Limited Warranty

Note: Please keep your sales docket as it provides evidence of warranty.

Warrantor: Uniden Australia Pty Limited ABN 58 001 865 498

Uniden New Zealand Limited

Warranty only available in original country of purchase

Elements of Warranty: Uniden warrants to the original retail owner for the duration of this warranty, its uh012sx UHF CB Radio (hereinafter referred to as the Product) to be free from defects in materials and craftsmanship with only the limitations or exclusions set out below.

Warranty Duration: This warranty to the original retail owner only, shall terminate and be of no further effect TWO (2) Years after the date of original retail sale. This warranty will be deemed invalid if the product is; (A) Damaged or not maintained as reasonable and necessary, (B) Modified, altered or used as part of any conversion kits, subassemblies, or any configurations not sold by Uniden, (C) Improperly installed, (D) Repaired by someone other than an authorized Uniden Repair Agent for a defect or malfunction covered by this warranty, (E) Used in conjunction with any equipment or parts or as part of a system not manufactured by Uniden, (F) Installed, programmed or serviced by anyone other than an authorized Uniden Repair Agent, or (G) Where the Serial Number label of the product has been removed or damaged beyond recognition.

Parts Covered: This warranty covers for 2 years, the main unit only.

Accessories: Microphone, Power cord etc are covered for 90 days.

Statement of Remedy: In the event that the product does not conform to this warranty at any time while this warranty is in effect, the warrantor at its discretion, will repair the defect or replace the product and return it to you without charge for parts and service. THIS WARRANTY DOES NOT COVER OR PROVIDE FOR THE REIMBURSEMENT OR PAYMENT OF INCIDENTAL OR CONSEQUENTIAL DAMAGES. THIS GUARANTEE IS IN ADDITION TO AND DOES NOT AFFECT YOUR RIGHTS UNDER THE CONSUMER GUARANTEES ACT.

Procedure for obtaining performance or warranty: In the event that the Product does not conform to this warranty, the Product should be shipped or delivered, freight prepaid, with evidence of original purchase, (eg. a copy of the sales docket), to the warrantor at:

UNIDEN AUSTRALIA PTY LTD

Service Division
345 Princes Highway,
Rockdale, NSW 2216
Fax (02) 9599 3278

UNIDEN NEW ZEALAND LTD

Service Division
150 Harris Road, East Tamaki,
Auckland
Fax (09) 274 4253

Uniden®

© 2005 Uniden Australia Pty Limited/Uniden New Zealand Limited
Printed in China UTZZ01932ZB(0)

UH047SX-2 Operating Guide



Uniden®

To bring outstanding wireless Communication products
to people's lives throughout the world.

CONTROL & INDICATORS

INCLUDED IN YOUR PACKAGE:

- UH047SX-2 Radio (2)
- Operating Guide
- Belt Clip (2)
- Charging Cradle with AC Adaptor
- NiMH Battery Pack (2)
- VOX Headset (2)

OPTIONAL ACCESSORIES

- VOX Earset
- Carry Case
- Speaker Mic

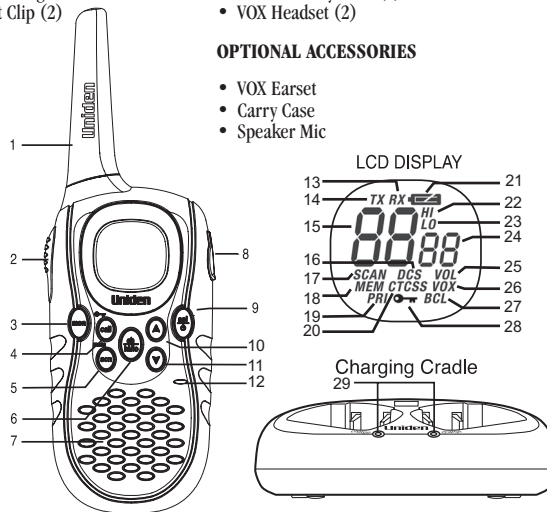

- | | |
|---------------------------|--|
| 1 Antenna | 16 DCS ON Indicator |
| 2 PTT(Push-To-Talk) Key | 17 Scan Indicator |
| 3 Monitor Key | 18 Memory Indicator |
| 4 Keylock/Call Key | 19 Priority Channel Indicator |
| 5 Memory/Scan Key | 20 CTCSS ON Indicator |
| 6 Channel/Power Hi-Lo Key | 21 Battery Level Indicator |
| 7 Speaker | 22 HI Transmit Indicator |
| 8 Headset Jack | 23 Lo Transmit Indicator |
| 9 Select/Power On-Off Key | 24 CTCSS and DCS Code/Volume Level Indicator |
| 10 Volume/Select Up Key | 25 Volume Setting Indicator |
| 11 Volume/Select Down Key | 26 VOX Indicator |
| 12 Microphone | 27 Busy Channel Lockout Indicator |
| 13 Receive Indicator | 28 Keypad Lock Indicator |
| 14 Transmit Indicator | 29 Charging LED's |
| 15 Channel Indicator | |

GETTING STARTED



Uniden does not represent this product to be waterproof. Do not expose this product to Rain or Moisture.

BATTERY INSTALLATION

Your UH047SX unit uses the included NiMH battery pack for power. The unit can be powered with optional 4 AAA ALKALINE batteries.



If you don't use the UH047SX for long periods, Uniden recommend removing the batteries. The UH047SX is designed to retain the previous user settings. This feature will continue to use a small amount of battery power while the unit is switched off.



To avoid damage to the unit do not mix old and new batteries.

To install the batteries:

1. Make sure your radio is off.
2. Release the battery cover clip, then remove the battery cover.
3. Insert NiMH battery pack according to the orientation on the battery pack.

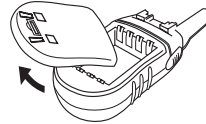

OR

Insert 4 AAA ALKALINE batteries (not included) according to the polarity symbols inside the battery compartment.

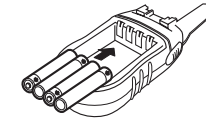

4. Align the battery cover tabs with the UH047SX tab holes then replace the cover clip.

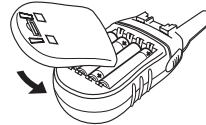

Do not charge alkaline or non rechargeable batteries.



INSTALLING THE CHARGE CRADLE

1. Plug the AC adaptor into the rear of the charge cradle and into the mains power.

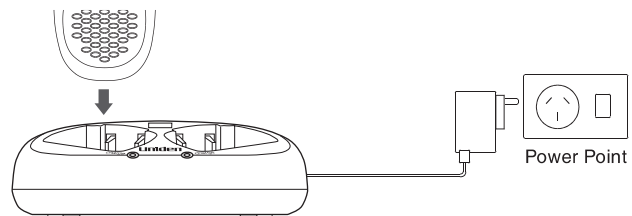

2. Place the UH047SX into the charge cradle. The charge light will come on to indicate the unit is charging.
3. Before operating the UH047SX, charge the battery pack for 16 hours.



Do not charge alkaline or non rechargeable batteries.



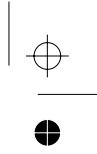
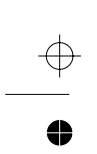

BELT CLIP

To attach the belt clip:
Slide the belt clip until it snaps into place.

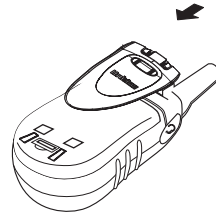

To remove the belt clip:
To remove the belt clip, press and hold belt clip locker, slide the belt clip at the same time until released.

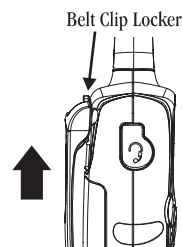

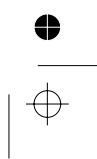
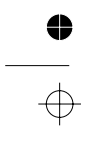

LOW BATTERY ALERT

If the battery level becomes low, the battery indicator icon on the display begins flashing. When the batteries in the unit are low, the unit will go into a battery Low mode. The Transmit mode is disabled. Replace the alkaline batteries immediately or if you are using the NiMH battery pack, place the radio on the charge cradle to recharge. Full charge will take up to 16 Hrs.





OPERATION

POWER ON/OFF

1. Press and hold **select**/ key to turn the radio on. A channel number will appear on the display.
2. Press and hold **select**/ key to turn the radio off.





VOLUME

1. Press  or  key to increase or decrease the volume level. VOL icon appears on the display while volume is being adjusted. There are 8 volume levels. Level 0 (No Audio) to Level 7 (Maximum Volume).





ADJUSTING THE KEY BEEPS

Your radio emits a beep each time one of the keys (except for the PTT button) is pressed.



1. To turn OFF this beep: Press and hold  /**call** key while turning on the radio.
2. To turn ON this beep: Press and hold  /**call** key while turning on the radio.

ROGER BEEP

Roger Beep is a BEEP that is sent to notify the end of transmission (both PTT and VOX transmission.) Roger Beep can be heard through the speaker when Key Beep is on. Roger Beep is transmitted even if Key Beep is turned off. However, Roger Beep will not be heard from the speaker.

1. To turn OFF Roger Beep: Press and hold  key while turning on the radio.
2. To turn ON Roger Beep: Press and hold  key while turning on the radio.

KEYLOCK ON/OFF

1. Press  /**call** key for 1.5 seconds to enter keylock on mode.
2. Press  /**call** key for 1.5 seconds while in Keylock mode to exit the Keylock mode.



While in Keylock on mode, the UH047SX can still receive and transmit.



SELECTING A CHANNEL

1. Press **cb/bi/lo** key momentarily to activate channel select mode. The displayed channel will flash.
2. Press ▲ or ▼ key to select the desired channel.



For your reference a list of the available channels, corresponding frequencies and guidelines for their use is printed on page 12. For Australia, Channels 05 and 35 are reserved for Emergency Calls.



3. Press **cb/bi/lo** key momentarily to exit channel select mode. If no button is pressed within 5 sec the UH047SX will exit from the channel select mode.

TO TRANSMIT AND RECEIVE

The UH047SX uses the 40 UHF-CB Channels (**Channels 22 and 23 are for telemetry and telecommand applications. Transmit is inhibited on these channels**).



1. Before you transmit, listen for activity on the selected channel.
2. When the channel is clear, press and hold the PTT button to transmit. 'TX' icon appears on the display.

Hold the radio with microphone approximately 5 cm in front of your mouth with the antenna at approximately 45° angle away from your head. Speak in a clear, normal conversational voice.

3. When you have finished speaking, release the PTT and listen for a response. 'TX' icon then disappears on the display. While receiving, the 'RX' icon is displayed.

TRANSMIT HI/Lo POWER SELECT

1. Press and hold **cb/bi/lo** key to select desired transmit level. 'HI' icon will appear on the display for maximum transmit level. 'LO' icon will appear on the display for minimum transmit level. The RF transmit power of the UH047SX is selectable between 1.0W/0.5W.





AUTOMATIC SQUELCH FEATURE

The UH047SX is equipped with an Automatic Squelch System which shuts off weak transmissions and unwanted noise.

MONITOR

This feature enables users to listen for weak signals on the current channel at the press of a button.

To use monitor:

1. Press **mon** button. The 'RX' icon will flash.
2. Release within 1.5 seconds and the unit exits Monitor mode.
3. Press and hold **mon** button for 2 seconds for continuous listening.
The receiver circuit will stay open, letting in both the noise & weak signals. The 'RX' icon flashes in this status.
4. To return to normal Receive mode press **mon** button. The 'RX' icon disappears or stops flashing in this status.



SCANNING

The scan function scans all channels which are stored in the SCAN CHANNEL MEMORY and stops at an active channel. If a PRIORITY channel has been selected then this channel will be monitored for activity every 3 seconds. When the signal stops, the UH047SX waits 2 seconds (Reply Delay) before scanning resumes.

To initiate scanning:

1. Press **mem/SCN** key momentarily to begin scanning.
The 'SCAN' icon is displayed.
2. Press **select/**  key or **mem/SCN** key to cancel.

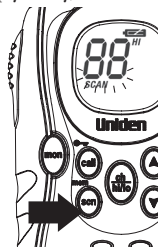



REPLY DELAY

While scanning, the UH047SX stops at a busy channel and receives a transmission. When the received signal is over, the unit will wait for 2 seconds for the return of the signal, otherwise, the radio resumes scanning.

TO OPERATE IN DUPLEX MODE (REPEATERS)

The Duplex function enables you to access local repeater stations. You can only activate Duplex from CH01-CH08.

UHF CB Repeaters are used to retransmit or relay your signal. Repeaters will extend the range of your radio and overcome the shielding effect caused by solid obstructions.



Contact your retailer for a list of repeaters available in Your area.

Operation with the aid of a Repeater

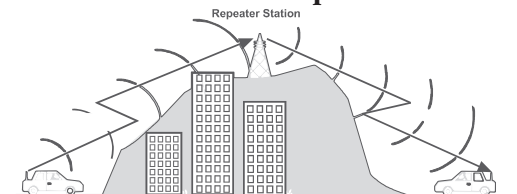

1. Press **select/** key six times. **dp** appears on the display.
2. Press **▲** or **▼** to change to **r**.
3. Press **select/** to confirm

To deactivate the duplex operation repeat activation process and change **r** to . UH047SX will return to normal operation.



*If **▲** or **▼** key is pressed when the channel is not from Cb01 - Cb08, an error tone sounds.*







CTCSS & DCS

(Continuous Tone Coded Squelch System) & (Digital Coded Squelch)

CTCSS is a feature that allows a group to talk to each other without hearing other users on the same channel.



1. Press **select/**  key momentarily to enter CTCSS mode. The current selected CTCSS tone flashes.
2. Press **▲** key to select the required CTCSS tone (OFF or 1-38).
3. Press **select/**  key six times to exit and confirm the selected setting.



For channels with a CTCSS tone setting, the CTCSS tone is displayed below the channel indicator. For channels with the setting of CTCSS OFF, there will be no display below the channel indicator.

DCS

DCS is a digital extension of CTCSS. It provides 104 extra, digitally coded, squelch codes that follow after the 38 CTCSS codes. CTCSS 1-38, followed by DCS 1-99 plus DCS 100-104 (represented by 00-04 on the display).

1. Press **select/**  key momentarily to enter CTCSS/DCS mode.
2. Use **▲** key to select a DCS code. The DCS codes follow on after the CTCSS codes. The DCS icon will replace the CTCSS code on the display.
3. Press **select/**  key six times to exit and confirm the selected setting.



The DCS icon will appear when selected. To turn off DCS select CTCSS OFF and no display will show below the channel indicator.





*Channels 5 and 35 are used for emergency channels.
Transmit is inhibited on channels 22 and 23.
CTCSS and DCS will not operate on these channels.*





VOX

VOX is the automatic transmitting function by inputting voice into the VOX headset mic without pressing the PTT button.

1. Press **select/**  key momentarily twice while in standby mode to enter VOX Sensitivity mode. The current selected VOX setting will flash on the display.
2. Press **▲** or **▼** key to adjust the VOX sensitivity. 1 is the highest sensitivity and 4 is the lowest sensitivity. VOX can be turned off by selecting 'oF' icon.
3. Press **select/**  key five times to confirm the setting and exit to standby mode.





The 'VOX' icon is shown on the display when VOX is selected to on and VOX Headset is plugged into VOX Headset Jack.

The 'TX' icon blinks when the voice level is possible to transmit at the current selected VOX sensitivity level.

TRANSMITTING A CALL TONE

Your UH047SX radio is equipped with 5 selectable call tones that will be transmitted when the  /call key is pressed momentarily.

To select a call tone:

1. Press **select/**  key momentarily three times while in standby mode to enter Call Tone mode. The current call tone number (C1-C5) will be indicated.
2. Press the **▲** or **▼** key to select desired call tone. Each tone will be heard through the speaker.
3. Press **select/**  key four times to confirm and exit to standby mode. To transmit the selected call tone, press the  /call key. The selected tone will automatically be transmitted for a fixed length of time. Call Tone will be cancelled when the **PTT** button is pressed.





Current regulations require calling tones to be restricted to one transmission per minute. If a second transmission is attempted within one minute then an error tone will sound.





PRIORITY SCAN CHANNEL

To set a priority scan channel:



1. Press **select/**  momentarily four times while in standby mode to enter Priority Scan Channel mode. The current priority channel will be indicated.
2. Press **▲** or **▼** key to increase or decrease the desired channel number.
3. Press **select/**  three times to confirm and exit to standby mode. **PRI** will be displayed when a priority channel has been selected.



BCL (Busy Channel Lockout) ON/OFF

BCL is used when CTCSS or DCS is selected to prevent transmission when the UH047SX detects a transmission from another unit using the same CTCSS or DCS code.

To set BCL ON/OFF:

1. Press **select/**  momentarily five times while in standby mode to enter **BCL ON/OFF** mode. The current BCL status will be indicated.
2. Press **▲** or **▼** key to select **ON** (on) or **OFF** (oF).
3. Press **select/**  two times to confirm and exit to standby mode. **BCL** will be displayed when BCL on has been selected.



SCAN CHANNEL MEMORY

To store a channel into Scan Channel Memory:

1. Select desired channel using **ch/bi/lo** key and **▲** or **▼** key.
2. Press and hold **mem/SCN** key. **MEM** will appear on the display.

Repeat steps 1 and 2 to clear channel from Scan Channel Memory.



UHF CB CHANNELS & FREQUENCIES



Please follow these guidelines for channel use in Australia:

- Channels 05 and 35 are Emergency Channels.
- Channel 11 is a Calling Channel. Channels 22 and 23 are for telemetry and telecommand applications and TX is inhibited on these channels.

General communication is accepted on all other channels with these guidelines:

- Channel 40 - road channel (Australia).
- Channels 01-08 (and 31-38) are repeater channels.

CH No.	Simplex Mode Transmit / Receive Frequency (MHz)	Duplex Mode Transmit Frequency (MHz)	CH No.	Simplex Mode Transmit/Receive Frequency (Mhz)
1	476.425	477.175 CH31	21	476.925
2	476.450	477.200 CH32	22	476.950 (RX only)
3	476.475	477.225 CH33	23	476.975 (RX only)
4	476.500	477.250 CH34	24	477.000
5	476.525	477.275 CH35	25	477.025
6	476.550	477.300 CH36	26	477.050
7	476.575	477.325 CH37	27	477.075
8	476.600	477.350 CH38	28	477.100
9	476.625		29	477.125
10	476.650		30	477.150
11	476.675		31	477.175
12	476.700		32	477.200
13	476.725		33	477.225
14	476.750		34	477.250
15	476.775		35	477.275
16	476.800		36	477.300
17	476.825		37	477.325
18	476.850		38	477.350
19	476.875		39	477.375
20	476.900		40	477.400

CTCSS & DCS Code List

CTCSS Code LIST

Code No.	Frequency (Hz)	Code No.	Frequency (Hz)	Code No.	Frequency (Hz)
"oF"	OFF	13	103.5	26	162.2
1	67.0	14	107.2	27	167.9
2	71.9	15	110.9	28	173.8
3	74.4	16	114.8	29	179.9
4	77.0	17	118.8	30	186.2
5	79.7	18	123.0	31	192.8
6	82.5	19	127.3	32	203.5
7	85.4	20	131.8	33	210.7
8	88.5	21	136.5	34	218.1
9	91.5	22	141.3	35	225.7
10	94.8	23	146.2	36	233.6
11	97.4	24	151.4	37	241.8
12	100.0	25	156.7	38	250.3

DCS Code LIST

Code No.	DCS Code (Octal)	Code No.	DCS Code (Octal)	Code No.	DCS Code (Octal)	Code No.	DCS Code (Octal)
1	023	27	152	53	311	79	466
2	025	28	155	54	315	80	503
3	026	29	156	55	325	81	506
4	031	30	162	56	331	82	516
5	032	31	165	57	332	83	523
6	036	32	172	58	343	84	526
7	043	33	174	59	346	85	532
8	047	34	205	60	351	86	546
9	051	35	212	61	356	87	565
10	053	36	223	62	364	88	606
11	054	37	225	63	365	89	612
12	065	38	226	64	371	90	624
13	071	39	243	65	411	91	627
14	072	40	244	66	412	92	631
15	073	41	245	67	413	93	632
16	074	42	246	68	423	94	654
17	114	43	251	69	431	95	662
18	115	44	252	70	432	96	664
19	116	45	255	71	445	97	703
20	122	46	261	72	446	98	712
21	125	47	263	73	452	99	723
22	131	48	265	74	454	100	731
23	132	49	266	75	455	101	732
24	134	50	271	76	462	102	734
25	143	51	274	77	464	103	743
26	145	52	306	78	465	104	754



WARRANTY

UNIDEN UH047SX UHF CB RADIO

Limited One Year Warranty



Please keep your sales docket as it provides evidence of warranty.

Warrantor: Uniden Australia Pty Limited ABN58 001 865 498 Uniden New Zealand Limited.

Warranty only available in original country of purchase.

Elements of Warranty: Uniden warrants to the original retail owner for the duration of this warranty, its UH047SX UHF CB Transceiver Radio (hereinafter referred to as the Product) to be free from defects in materials and craftsmanship with only the limitations or exclusions set out below.

Warranty Duration: This warranty to the original retail owner only, shall terminate and be of no further effect ONE (1) Year after the date of original retail sale. This warranty will be deemed invalid if the Product is: (A) Damaged or not maintained as reasonable and necessary, (B) Modified, altered or used as part of any conversion kits, subassemblies, or any configurations not sold by Uniden, (C) Improperly installed, (D) Repaired by someone other than an authorised Uniden Repair Agent for a defect or malfunction covered by this warranty, (E) Used in conjunction with any equipment or parts or as part of a system not manufactured by Uniden, (F) Installed, programmed or serviced by anyone other than an authorised Uniden Repair Agent, or (G) Where the Serial Number label of the product has been removed or damaged beyond recognition.

Parts Covered: This warranty covers for 1 year, the UHF CB Transceiver Unit only.

Accessories: Belt Clip, Battery cover, Batteries etc are covered for 90 days.

Statement of Remedy: In the event that the product does not conform to this warranty at any time while this warranty is in effect, the warrantor at its discretion, will repair the defect or replace the product and return it to you without charge for parts and service. This warranty does not cover provide for the reimbursement or payment of incidental or consequential damages.

Procedure for Obtaining Performance or Warranty: In the event that the Product does not conform to this warranty, the Product should be shipped or delivered, freight prepaid with evidence of original purchase, (eg. a copy of the sales docket), to the warrantor at:

UNIDEN AUSTRALIA PTY LIMITED
Service Division
345 Princes Highway, Rockdale, NSW 2216
Fax (02) 9599 3278
www.uniden.com.au

UNIDEN NEW ZEALAND LIMITED
Service Division
150 Harris Road, East Tamaki, Auckland
Fax (09) 274 4253
www.uniden.co.nz

Customers in other states should ship or deliver the Product freight pre-paid to the nearest Uniden Authorised Repair Centre. (Contact Uniden for the Warranty Agent nearest you.)



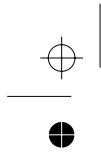

Uniden®

© 2005 Uniden Australia Pty Limited/Uniden New Zealand Limited
Printed in China UTZZ01929ZA(0)

